

ALOPLASTIKA / PRIMOIMPLANTÁTY

Primoimplantáty



Beznoska®

KATALOG

Materiály

ÚVOD

KYČEL

KOLENO

PALEC

Materiál	ISO	ČSN	DIN	ASTM
Tvářená korozivzdorná ocel	5832-1	17 350	W.Nr. 1.4441	F 138 Grade 2
Tvářená vysokodusíkatá korozivzdorná ocel	5832-9			
Nelegovaný titan	5832-2		W.Nr. 3.7035	F 67 Grade 1
Slitina titanu, hliníku 6 a vanadu 4 pro tváření (dále jen Ti6Al4V)	5832-3		W.Nr. 3.7165	F 136 TI-6Al-4V E.L-I.
Kobalt-chrom-molybdenová slitina litá (dále jen CoCrMo litý)	5832-4			F 75
Tvářená kobalt-chrom-molybdenová slitina (dále jen CoCrMo tvářený)	5832-12			
Ultravysokomolekulární polyetylen - Lisované formy (dále jen UHMWPE)	5834-2			F 648
Crosslinked ultravysokomolekulární polyetylen - Lisované formy (dále jen Crosslinked UHMWPE)	5834-2			F 648
Ultravysokomolekulární polyetylen - Lisované formy + vit. E (dále jen UHMWPE + vit. E)	5834-2			F 648
Polymetylmetakrylát (PMMA)				
Kompozitní materiály na bázi vysoce čisté matrice oxidu hlinitého s vyztužením zirkony (dále jen Keramika BIOLOX® delta)	6474-2			
Tepelně stříkané povlaky z hydroxyapatitu (dále jen Hydroxyapatit)	13779-2			

Obsah

Kyčel

Přehled implantátů	4 – 6
Femorální komponenty	7 – 15
Acetabulární komponenty	16 – 25
Hlavice	26 – 27

Koleno

Přehled implantátů	28 – 29
Femorální komponenty	30
Tibiální komponenty	31 – 33
Artikulační vložky	34 – 38
Patella	39

Palec

Přehled implantátů	40
Dříky necementované	41 – 42
Krčky	42 – 44
Jamky necementované	45 – 46
Jamky cementované	47
Náhrada trapezia	48

ÚVOD

KYČEL

KOLENO

PALEC

Kyčel

Cervikokapitální endoprotézy



BEZNOSKA CEP
(str. 7)



CSB
(str. 8)

Cementované dříky



CSB 12/14
(str. 9)



CSC
(str. 10)



BEZNOSKA
(str. 11)



TRIO cementovaný
(str. 12)

Necementované dříky



SF
(str. 14)



TRIO necementovaný
(str. 15)

Cementované jamky



BEZNOSKA
(str. 16 – 17)



02
(str. 18)

ÚVOD

KYČEL

KOLENO

PALEC

Necementované jamky



SF/II
(str. 20–21)



DUO
(str. 22–25)

Hlavice



Hlavice kovové
(str. 26)



Hlavice kobaltové
(str. 26)



Hlavice keramické
(str. 27)



Hlavice cervikokapitální
(str. 27)



Hlavice biartikulární
(str. 27)

BEZNOSKA - DŘÍK CEP

Materiál: • (ISO 5832-1) Tvářená korozi-vzdorná ocel



ØD [mm]	Objednací číslo	Kód VZP
38	314900	12571
40	315000	12572
42	315100	12573
44	315200	12574
46	315300	12575
48	315400	12576
50	315500	12577
52	315600	12578
54	315700	12579
56	315800	12580

ÚVOD

KYČEL

KOLENO

PALEC

CSB – Dřík

Materiál:

- (ISO 5832-9) Dřík - Tvářená vysokodusíkatá korozivzdorná ocel
- (ISO 5832-1) Hlavice - Tvářená korozivzdorná ocel
- Centralizér - PMMA

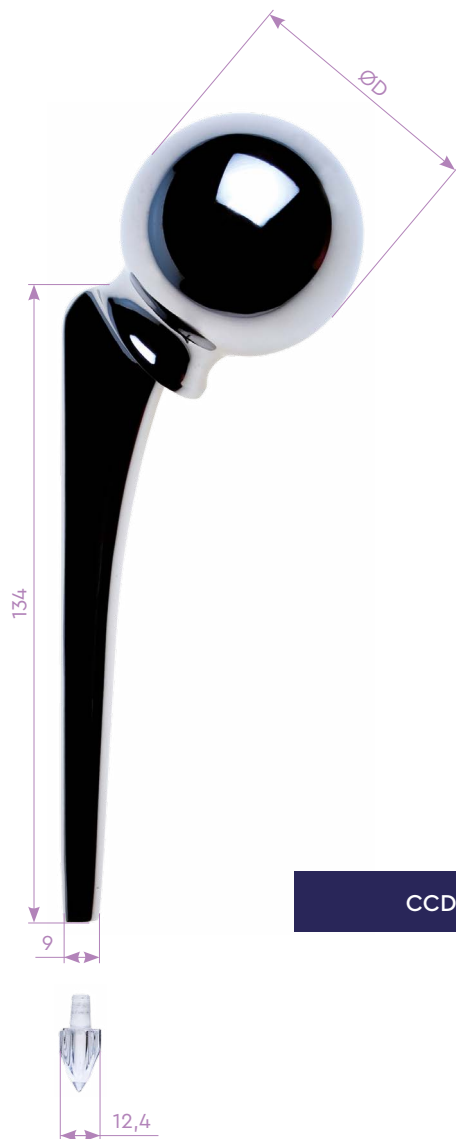

CCD úhel 135°

ØD [mm]	Objednací číslo	Kód VZP
40	315902	83188
42	315904	
44	315906	83189
46	315908	
48	315910	
50	315912	83190
52	315914	
54	315916	83191
56	315918	

Velikost centralizéru	Objednací číslo	Kód VZP
2	317012	30962

CSB - Dřík, 12/14

- Materiál:**
- (ISO 5832-9) Dřík - Tvářená vysokodusíkatá korozivzdorná ocel
 - Centralizér - PMMA



Objednací číslo	Kód VZP
317032	83199

Velikost centralizéru	Objednací číslo	Kód VZP
2	317012	30962

ŮVOD

KYČEL

KOLENO

PALEC

CSC - Dřík cementovaný, 12/14

- Materiál:**
- (ISO 5832-9) Dřík - Tvářená vysokodusíkatá korozivzdorná ocel
 - Centralizér - PMMA

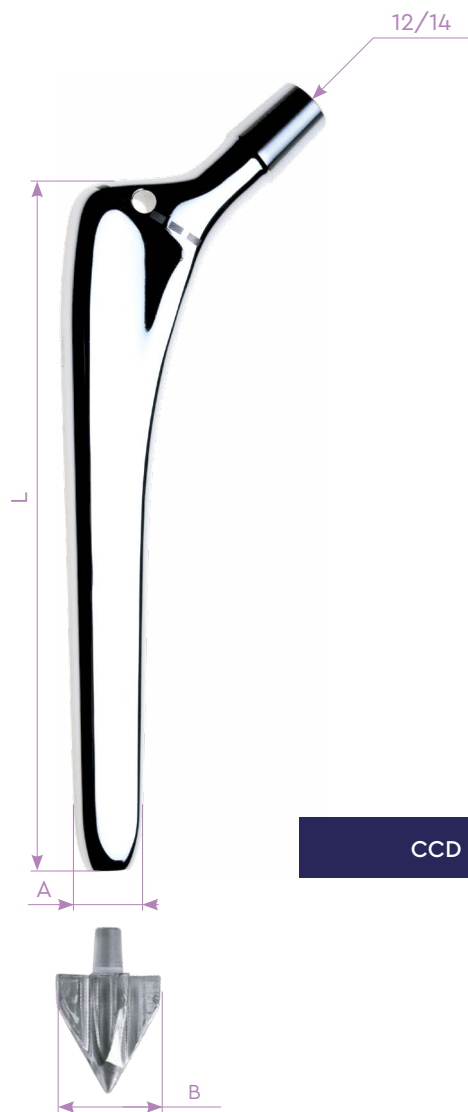

Velikost	A [mm]	L [mm]	Objednací číslo	Kód VZP
0	7,5	108	317000	30961
1	8	119	317001	
2	9	130	317002	
3	10	136	317003	
4	12	142	317004	
5	14	148	317005	

Velikost centralizéru	Velikost dříku	B [mm]	Objednací číslo	Kód VZP
1	0/1	10	317011	30962
2	2	12	317012	
3	3	14	317013	
4	4	16	317014	
5	5	18	317015	

BEZNOSKA - Dřík, 12/14, AK

Materiál: • (ISO 5832-1) Tvářená korozivzdorná ocel

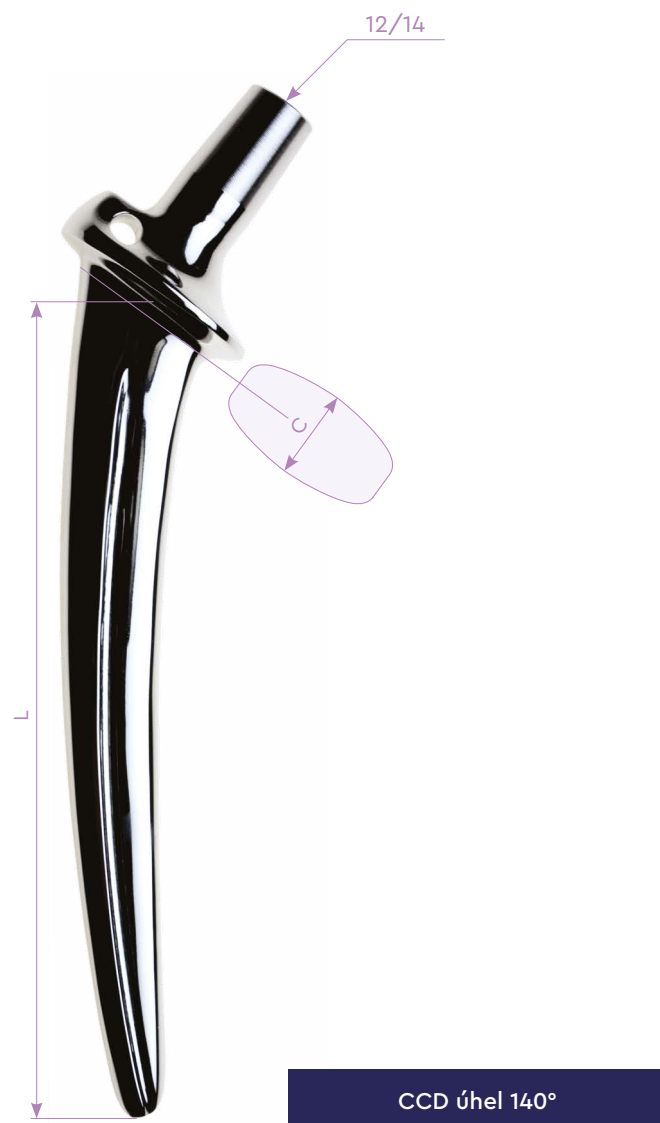

Velikost	L [mm]	C [mm]	Objednací číslo	Kód VZP
1-N	93	9,5	310905	20589
1-S		11	310910	20589
2-N	110	9,5	310915	20590
2-S		11	310920	20590
2-B		12,5	310925	20591
3-N	132	11	310930	20592
3-S		12,5	310935	20593
3-B		14	310940	20593

ÚVOD

KYČEL

KOLENO

PALEC

TRIO - Dřík cementovaný, 12/14

- Materiál:**
- (ISO 5832-9) Dřík - Tvářená vysokodusíkatá korozivzdorná ocel
 - Centralizér - PMMA

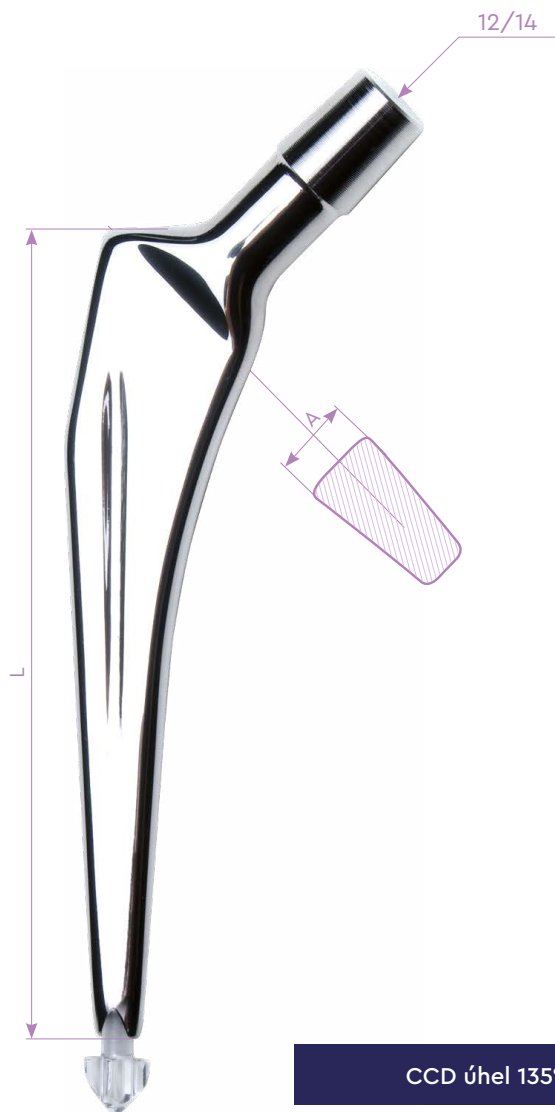

Dřík				
Velikost	L [mm]	A [mm]	Objednací číslo	Kód VZP
01	115	11,0	321999	110039
0	115	11,5	322000	
1	115	11,0	322001	
2	120	11,5	322002	
3	125	11,7	322003	
4	130	12,0	322004	
5	135	12,3	322005	
6	140	12,5	322006	
7	145	13,0	322007	
8	150	13,5	322008	

Velikost centralizéru	Objednací číslo	Kód VZP
01	317019	110040
0	317020	
1	317021	
2	317022	
3	317023	
4	317024	
5	317025	
6	317026	
7	317027	
8	317028	

ÚVOD

KYČEL

KOLENO

PALEC

Zátka pod cementovaný dřík

Materiál: • (ISO 5834-2) UHMWPE



$\varnothing D$ [mm]	Objednací číslo	Kód VZP
8	316000	70133
10	316002	
12	316004	
14	316006	
16	316008	
18	316010	

ÚVOD

KYČEL

KOLENO

PALEC

SF – Dřík necementovaný, 12/14

- Materiál:**
- (ISO 5832-3) Dřík - Ti6Al4V
 - (ISO 5832-2) Porézní vrstva - Nelegovaný titan

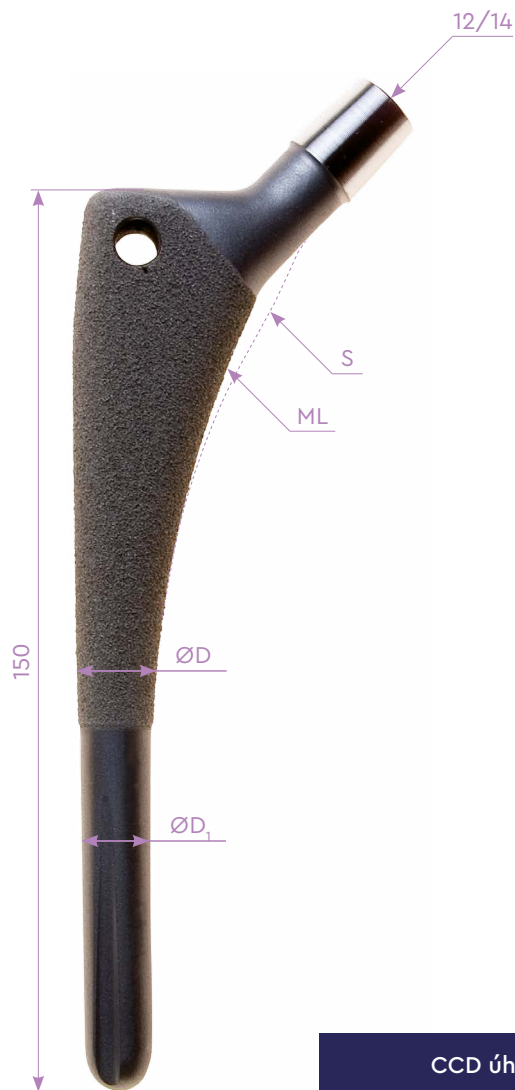

S – Standardní			
Velikost	ØD / ØD ₁ [mm]	Objednací číslo	Kód VZP
10/S	10,5 / 10	322210	72483
11/S	11,5 / 11	322220	72484
12/S	12,5 / 12	322230	72374
13/S	13,5 / 13	322240	72485
14/S	14,5 / 14	322250	72376
15/S	15,5 / 15	322260	72486
16/S	16,5 / 16	322270	74258
17/S	17,5 / 17	322280	74259
18/S	18,5 / 18	322290	74260

ML – Mediolaterálně zúžený			
Velikost	ØD / ØD ₁ [mm]	Objednací číslo	Kód VZP
10/ML	10,5 / 10	322410	72495
11/ML	11,5 / 11	322420	72496
12/ML	12,5 / 12	322430	72497
13/ML	13,5 / 13	322440	72498
14/ML	14,5 / 14	322450	72499
15/ML	15,5 / 15	322460	72500
16/ML	16,5 / 16	322470	74264
17/ML	17,5 / 17	322480	74265
18/ML	18,5 / 18	322490	74266

ÚVOD

KYČEL

KOLENO

PALEC

TRIO - Dřík necementovaný

- Materiál:**
- (ISO 5832-3) Dřík - Ti6Al4V
 - (ISO 5832-2) Porézní vrstva - Nelegovaný titan



Velikost	L [mm]	A [mm]	Objednací číslo	Kód VZP
01	115	12,0	322013	110041
0	115	12,5	322014	
1	115	13,0	322015	
2	120	13,5	322016	
3	125	14,0	322017	
4	130	14,5	322018	
5	135	15,0	322019	
6	140	15,5	322020	
7	145	16,0	322021	
8	150	16,5	322022	

ŮVOD

KYČEL

KOLENO

PALEC

BEZNOSKA - Cementovaná jamka

- Materiál:**
- (ISO 5834-2) Jamka - UHMWPE
 - (ISO 5832-1) Diagnostický drát - Tvářená korozivzdorná ocel

ÚVOD

KYČEL

KOLENO

PALEC



Standard					
ØA [mm]	Velikost	ØB [mm]	V [mm]	Objednací číslo	Kód VZP
28	S	44	27,5	329000	12601
	M	49	29,5	329100	12589
	L	54	33,5	329200	12602
32	M	49	29,5	327100	12589
	L	54	33,5	327200	12590

S okrajem					
ØA [mm]	Velikost	ØB [mm]	V [mm]	Objednací číslo	Kód VZP
28	S	49	27,5	329800	12606
	M	59	29,5	329900	12593
	L	64	33,5	330000	12594
32	M	59	29,5	327600	12593
	L	64	33,5	327700	12594

Plochá					
ØA [mm]	Velikost	ØB [mm]	V [mm]	Objednací číslo	Kód VZP
28	S	44	23	329300	12603
	M	49	24	329400	12591
32	M	49	24	327300	12591
	L	54	25	327400	12592



Antiluxační					
ØA [mm]	Velikost	ØB [mm]	V [mm]	Objednáací číslo	Kód VZP
28	S	44	27,5	329500	12604
	M	49	29,5	329600	12599
	L	54	33,5	329700	12605
32	M	49	29,5	328400	12599
	L	54	33,5	328500	12600

Antiluxační s okrajem					
ØA [mm]	Velikost	ØB [mm]	V [mm]	Objednáací číslo	Kód VZP
32	M	59	29,5	328100	12597
	L	64	33,5	328200	12598

Plochá s okrajem					
ØA [mm]	Velikost	ØB [mm]	V [mm]	Objednáací číslo	Kód VZP
28	S	49	24	330100	12595
	M	54	24	330200	12596

ÚVOD

KYČEL

KOLENO

PALEC

02 - Jamka cementovaná

- Materiál:**
- (ISO 5834-2) Jamka - Crosslinked UHMWPE
 - Centralizéry - PMMA
 - (ISO 5832-1) Diagnostický drát - Tvářená korozivzdorná ocel

ÚVOD

KYČEL

KOLENO

PALEC

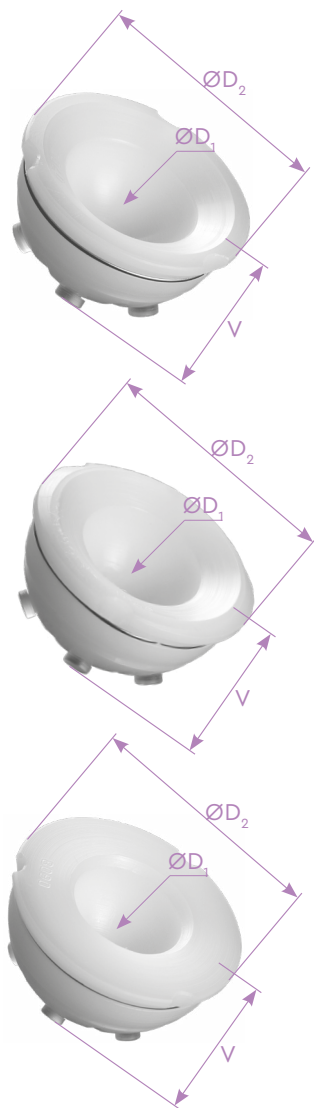

	ØD ₁ = 28 mm				ØD ₁ = 32 mm				ØD ₁ = 36 mm			
	ØD ₂ [mm]	V [mm]	Objednáací číslo	Kód VZP	ØD ₂ [mm]	L [mm]	Objednáací číslo	Kód VZP	ØD ₂ [mm]	L [mm]	Objednáací číslo	Kód VZP
Standard/N	44	25	330880	42464	48	29	330931	42465	54	32	330838	111702
	46	26	330881		50	30	330932		56	33	330839	
	48	27	330882		52	31	330933		58	34	330840	
	50	28	330883		54	32	330934		60	35	330841	
	52	29	330884		56	33	330935		62	36	330842	
	54	30	330885		58	34	330936		64	37	330843	
	56	31	330886		60	35	330937		66	38	330844	
	58	32	330887									
Offset/10	44	25	330890	42466	48	29	330941	42467	54	32	330846	111703
	46	26	330891		50	30	330942		56	33	330847	
	48	27	330892		52	31	330943		58	34	330848	
	50	28	330893		54	32	330944		60	35	330849	
	52	29	330894		56	33	330945		62	36	330850	
	54	30	330895		58	34	330946		64	37	330851	
	56	31	330896		60	35	330947		66	38	330852	
	58	32	330897									
Antiluxační	46	26	330901	42468	48	29	330951	42469	54	32	330854	111704
	48	27	330902		50	30	330952		56	33	330855	
	50	28	330903		52	31	330953		58	34	330856	
	52	29	330904		54	32	330954		60	35	330857	
	54	30	330905		56	33	330955		62	36	330858	
	56	31	330906		58	34	330956		64	37	330859	
	58	32	330907		60	35	330957		66	38	330860	
	60	33	330908									

ÚVOD

KYČEL

KOLENO

PALEC

PRIMOIMPLANTÁTY

SF/II - Plášť jamky

- Materiál:**
- (ISO 5832-2) Plášť - Nelegovaný titan
 - (ISO 5832-2) Porézní vrstva - Nelegovaný titan
 - (ISO 5832-3) Pojistný drát - Ti6Al4V



*10 otvorů

SF - Šroub

- Materiál:**
- (ISO 5832-3) Ti6Al4V



SF - Šroub kortikální			
ØD [mm]	L [mm]	Objednáací číslo	Kód VZP
4,5	15	331906	72438
	20	331908	72438
	25	331910	72438
	30	331912	72439
	35	331914	72440
	40	331916	72441
	45	331918	72442
	55	331922	84809



SF - Šroub spongiózní			
ØD [mm]	L [mm]	Objednáací číslo	Kód VZP
6,5	20	331948	110044
	25	331950	72443
	30	331952	72444
	35	331954	72445
	40	331956	72446
	45	331958	72447
	55	331962	84810

ØD [mm]	V [mm]	3 otvory		12 otvorů	
		Objednáací číslo	Kód VZP	Objednáací číslo	Kód VZP
40	23	332328	83139		
42	24	332329			
44	25	332330			
46	26	332332	83140	332386*	
48	27	332334			
50	28	332336			
52	29	332338	83141	332388	
54	30	332340		332389	
56	31	332342		332390	
58	32	332344	83142	332391	112303
60	33	332346		332392	
62	34	332348		332393	
64	35	332350	83143	332394	
66	36	332352		332395	
68	37	332354		332396	
70	38			332397	
72	39			332398	

SF/II - Vložka

Materiál: • (ISO 5834-2) Crosslinked UHMWPE

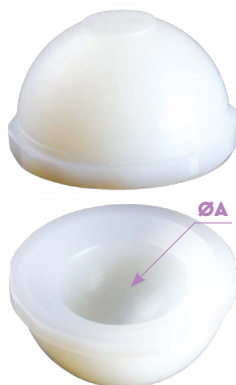

	ØA [mm]	22		28		32		36							
		Pro Ø pláště [mm]	Objednací číslo	Kód VZP	Objednací číslo	Kód VZP	Objednací číslo	Kód VZP	Objednací číslo	Kód VZP					
SF – Vložka standard/N	40		332498	83155											
	42		332499												
	44		332500												
	46			332502											
	48			332504											
	50			332506							332606	83168			
	52			332508							332608				
	54			332510							332610		332581		
	56			332512							332612		332582		
	58			332514							332614		332583		
	60			332516							332616		332584		
	62			332518							332618		332585		
	64			332520							332620		332586		
	66			332522							332622		332587		
	68			332524							332624		332588		
SF – Vložka s offsetem/10	40		332528	83160											
	42		332529												
	44		332530												
	46			332532							83160				
	48			332534											
	50			332536								332636		83172	
	52			332538								332638			
	54			332540								332640			332591
	56			332542								332642			332592
	58			332544								332644			332593
	60			332546								332646			332594
	62			332548								332648			332595
	64			332550								332650			332596
	66			332552								332652			332597
	68			332554								332654			332598

ŮVOD

KYČEL

KOLENO

PALEC

DUO – Plášť necementované jamky / s HA

Materiál:

- (ISO 5832-3) Plášť - Ti6Al4V
- (ISO 5832-2 + ISO 13779-2) Porézní vrstva - Nelegovaný titan + Hydroxyapatit

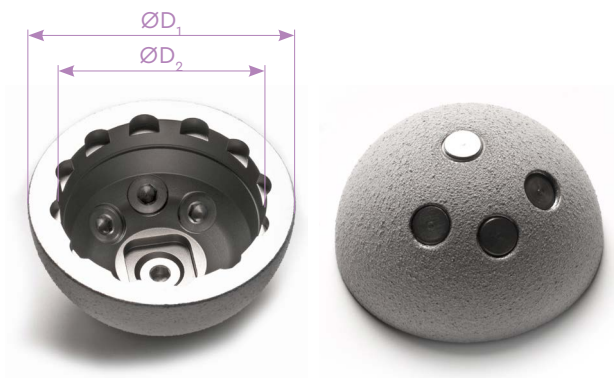

		Plášť jamky		Plášť jamky s HA	
ØD ₁ [mm]	ØD ₂ [mm]	Objednací číslo	Kód VZP	Objednací číslo	Kód VZP
46	37	332700	114954	332701	114955
48	37	332702		332703	
50	39	332704		332705	
52	39	332706		332707	
54	44	332708		332709	
56	44	332710		332711	
58	48	332712		332713	
60	48	332714		332715	
62	52	332716		332717	
64	52	332718		332719	
66	52	332720		332721	
68	52	332722		332723	

ÚVOD

KYČEL

KOLENO

PALEC

DUO – Šroub

Materiál: • (ISO 5832-3) Ti6Al4V

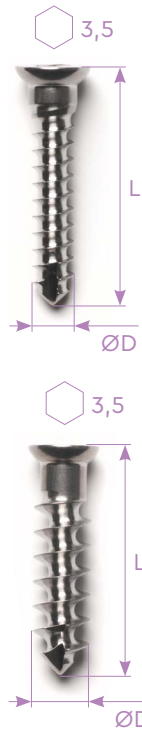

	ØD [mm]	L [mm]	Objednací číslo	Kód VZP
šroub kortikální	4,5	15	331930	114959
		20	331931	
		25	331932	
		30	331933	
		35	331934	
		40	331935	
		45	331936	
		55	331937	
šroub spongiózní	6,5	20	331940	114959
		25	331941	
		30	331942	
		35	331943	
		40	331944	
		45	331945	
		55	331946	

ÚVOD

KYČEL

KOLENO

PALEC

DUO – Vložka

Materiál: • (ISO 5834-2) Crosslinked UHMWPE



Pro Ø hlavice [mm]	Pro Ø pláště [mm]	ØA/D [mm]	Standard/N		Offset/10	
			Objednáací číslo	Kód VZP	Objednáací číslo	Kód VZP
28	46	28/37	332730	114958	332760	114958
	48					
	50					
	52	28/39	332732		332762	
	54					
	56	28/44	332734		332764	
	58					
	60	28/48	332736		332766	
	62					
	64	28/52	332738		332768	
66						
68						
54	32/44			332742		332772
56						
32	58	32/48	332744	114958	332774	114958
	60					
	62	32/52	332746		332776	
	64					
	66					
	68					
36	58	36/48	332752	114958	332782	114958
	60					
	62	36/52	332754		332784	
	64					
	66					
	68					

ÚVOD

KYČEL

KOLENO

PALEC

Vložka keramická (BIOLOX[®] delta)

Materiál: • (ISO 6474-2) Keramika BIOLOX[®] delta



Pro Ø hlavice [mm]	Pro Ø pláště [mm]	ØA/D [mm]	Objednací číslo	Kód VZP
28	46	28/37	380014	115427
	48			
	50	28/39	380015	
	52			
32	50	32/39	380010	
	52			
	54	32/44	380016	
	56			
	58	32/48	380017	
	60			
	62	32/52	380018	
	64			
	66			
	68			
36	54	36/44	380011	
	56			
	58	36/48	380012	
	60			
	62	36/52	380013	
	64			
	66			
	68			

ŮVOD

KYČEL

KOLENO

PALEC

Hlavice kyčelního kloubu

Materiál:

- (ISO 5832-9) Hlavice kovová Ak - Tvářená vysokodusíkatá korozivzdorná ocel
- (ISO 5832-12) Hlavice kovová Co - CoCrMo tvářený
- (ISO 6474-2) Hlavice keramická - Keramika BIOLOX® delta
- (ISO 5832-1) Hlavice kovová, 12/14 - Tvářená korozivzdorná ocel
- Hlavice biartikulární:
 - (ISO 5832-1) Plášť hlavice - Tvářená korozivzdorná ocel
 - (ISO 5832-9) Vnitřní hlavice - Tvářená vysokodusíkatá korozivzdorná ocel
 - (ISO 5834-2) Výstelka pláště - UHMWPE

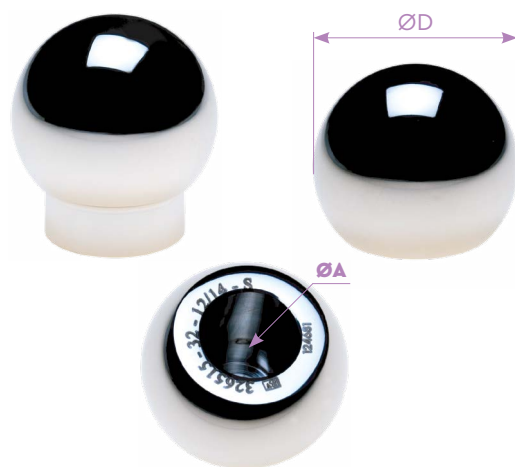

ØD [mm]	Délka krčku	Hlavice kovová Ak		Hlavice kovová Co	
		Objednací číslo	Kód VZP	Objednací číslo	Kód VZP
22	M			326722	83187
	L			326724	
28	S	326560		326760	77993
	M	326555	21806	326755	
	L	326550		326750	
	XL	326547	77764	326747	
	XXL	326545	83197	326745	
32	S	326515		326770	83186
	M	326510	21805	326772	
	L	326505		326774	
	XL	326502	77764	326776	
	XXL	326500	83197	326778	
36	S	326520		326740	111699
	M	326521		326741	
	L	326522	111698	326742	
	XL	326523		326743	
	XXL	326524		326744	



	ØD [mm]	Délka krčku	Objednací číslo	Kód VZP
Hlavice keramická	28	S	380001	105770
		M	380002	
		L	380003	
	32	S	380004	105771
		M	380005	
		L	380006	
	36	S	380007	105772
		M	380008	
		L	380009	

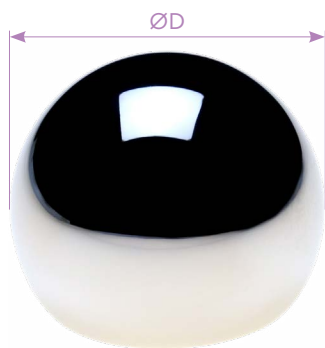

	ØD [mm]	Objednací číslo	Kód VZP
Hlavice kovová, 12/14	38	324600	6821
	40	324602	
	42	324604	
	44	324606	
	46	324608	
	48	324610	
	50	324612	
	52	324614	6822
	54	324616	
	56	324618	



	ØD [mm]	Objednací číslo	Kód VZP
Hlavice biartikulární	42	324915	21797
	44	324920	21798
	46	324925	21799
	48	324930	21780
	50	324935	21781
	52	324940	21782
	54	324945	21783
	56	324950	21784

ÚVOD

KYČEL

KOLENO

PALEC

Koleno

SVL/N



SVL/N
(str. 30 – 39)

SVS (s náhradou LCP)



SVS
(str. 30 – 39)

SVL/RP (s rotačním tibiálním platem)



SVL/RP
(str. 30 – 39)

ÚVOD

KYČEL

KOLENO

PALEC

Přípustné kombinace komponent kolenních náhrad

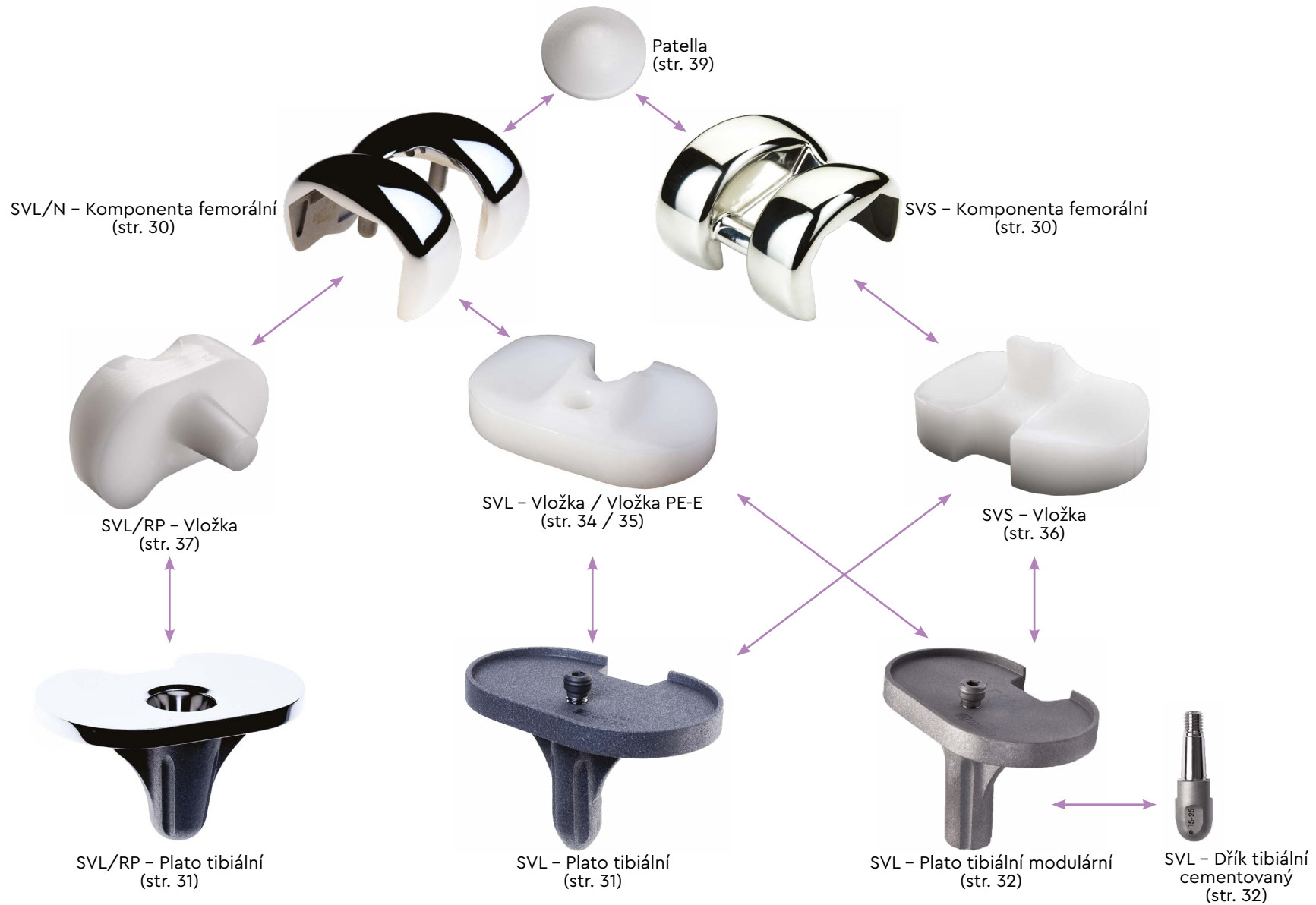

ÚVOD

KYČEL

KOLENO

PALEC

SVL/N - Komponenta femorální

Materiál: • (ISO 5832-4) CoCrMo litý

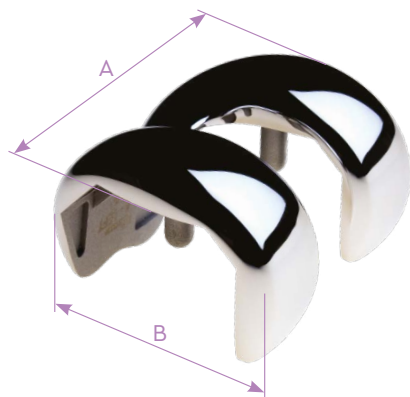

Provedení	Velikost	A [mm]	B [mm]	Objednací číslo	Kód VZP
Levé Ⓛ	1	57	52	350001	97991
	2	64	56	350002	
	3	70	60	350003	
	4	72	64	350004	
	5	76	68	350005	
	6	82	74	350006	
Pravé Ⓜ	1	57	52	350011	97993
	2	64	56	350012	
	3	70	60	350013	
	4	72	64	350014	
	5	76	68	350015	
	6	82	74	350016	

SVS - Komponenta femorální

Materiál: • (ISO 5832-4) CoCrMo litý



Provedení	Velikost	A [mm]	B [mm]	Objednací číslo	Kód VZP
Levé Ⓛ	1	57	52	351201	77768
	2	64	56	351202	
	3	70	60	351203	
	4	72	64	351204	
	5	76	68	351205	
	6	82	74	351206	
Pravé Ⓜ	1	57	52	352201	77769
	2	64	56	352202	
	3	70	60	352203	
	4	72	64	352204	
	5	76	68	352205	
	6	82	74	352206	

SVL - Plato tibiální

Materiál:

- (ISO 5832-3) Komponenta - Ti6Al4V
- Šroub - Ti6Al4V

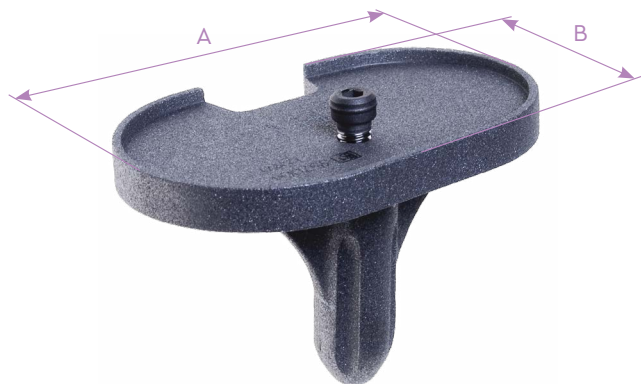

Provedení	Velikost	A [mm]	B [mm]	Objednací číslo	Kód VZP
Levé L	1	65	43	357001	71630
	2	70	47	357002	
	3	74	50	357003	
	4	80	53	357004	
	5	84	57	357005	
	6	89	60	357006	
Pravé R	1	65	43	358001	71632
	2	70	47	358002	
	3	74	50	358003	
	4	80	53	358004	
	5	84	57	358005	
	6	89	60	358006	

SVL/RP - Plato tibiální

Materiál:

- (ISO 5832-4) CoCrMo litý

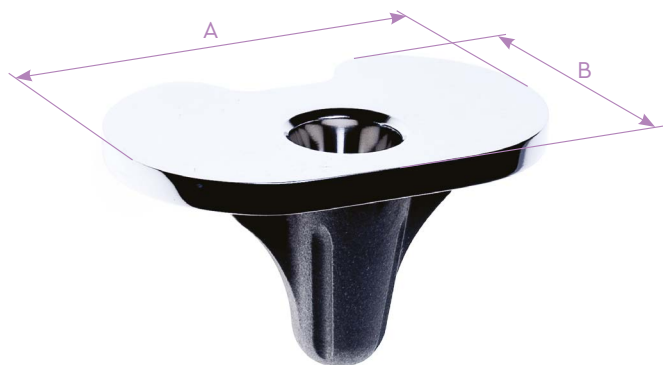

Velikost	A [mm]	B [mm]	Objednací číslo	Kód VZP
2	66	42	356202	97591
3	70	45	356203	
4	74	49	356204	
5	79	53	356205	97592
6	84	57	356206	

ÚVOD

KYČEL

KOLENO

PALEC

SVL - Plato tibiální modulární

Materiál:

- (ISO 5832-3) Komponenta - Ti6Al4V
- Šroub - Ti6Al4V

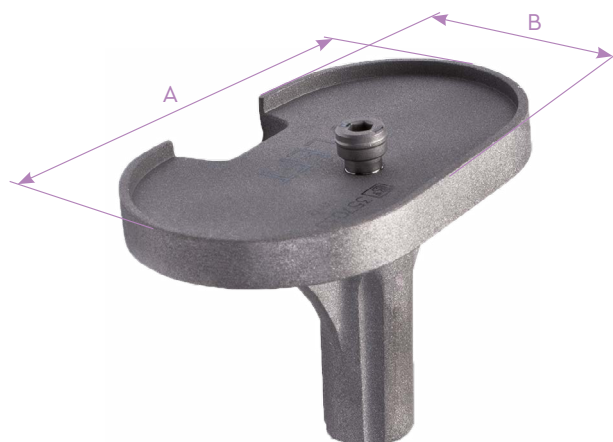

Provedení	Velikost	A [mm]	B [mm]	Objednací číslo	Kód VZP
Levé L	1	65	43	357031	111188
	2	70	47	357032	
	3	74	50	357033	
	4	80	53	357034	
	5	84	57	357035	
	6	89	60	357036	
Pravé R	1	65	43	358031	111189
	2	70	47	358032	
	3	74	50	358033	
	4	80	53	358034	
	5	84	57	358035	
	6	89	60	358036	

SVL - Dřík tibiální cementovaný

Materiál:

- (ISO 5832-3) Ti6Al4V



ØD [mm]	L [mm]	Objednací číslo	Kód VZP
12	25	360971	111190
	50	360972	
15	25	360975	
	50	360976	

SVL - Záslepka dříku tibiálního plata

- Materiál:**
- (ISO 5832-3) Ti6Al4V
 - PMMA



Materiál	Objednací číslo	Kód VZP
Ti	360970	111191
PMMA	360980	111190

ÚVOD

KYČEL

KOLENO

PALEC

SVL - Vložka

Materiál: • (ISO 5834-2) UHMWPE

ÚVOD

KYČEL

KOLENO

PALEC

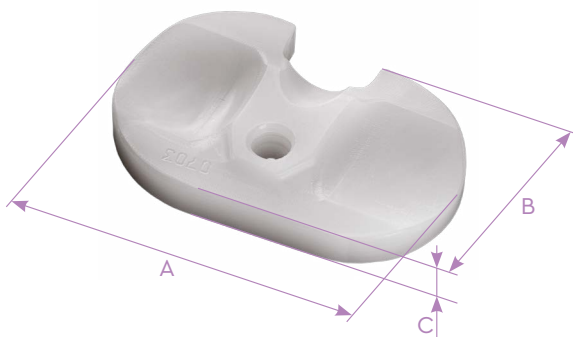

Velikost	C [mm]	A [mm]	B [mm]	Levé vložky		Pravé vložky	
				Objednací číslo	Kód VZP	Objednací číslo	Kód VZP
1	8	62	40	357041	71624	358041	71633
	10			357042		358042	
	12			357043		358043	
	15			357044		358044	
	18			357045		358045	
2	8	67	44	357051	71625	358051	71634
	10			357052		358052	
	12			357053		358053	
	15			357054		358054	
	18			357055		358055	
3	8	71	47	357061	71626	358061	71635
	10			357062		358062	
	12			357063		358063	
	15			357064		358064	
	18			357065		358065	
4	8	77	50	357071	71627	358071	71636
	10			357072		358072	
	12			357073		358073	
	15			357074		358074	
	18			357075		358075	
5	8	81	54	357081	71628	358081	71637
	10			357082		358082	
	12			357083		358083	
	15			357084		358084	
	18			357085		358085	
6	8	86	57	357091	71629	358091	71638
	10			357092		358092	
	12			357093		358093	
	15			357094		358094	
	18			357095		358095	

SVL - Vložka PE-E

Materiál: • (ISO 5834-2) UHMWPE + vit. E

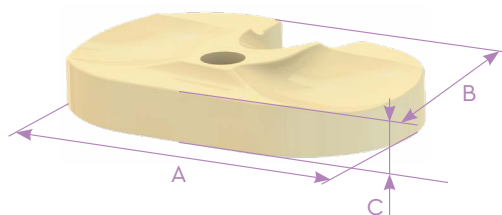

Velikost	C [mm]	A [mm]	B [mm]	Levé vložky		Pravé vložky	
				Objednací číslo	Kód VZP	Objednací číslo	Kód VZP
1	8	62	40	357111	116446	358111	116446
	10			357112		358112	
	12			357113		358113	
	15			357114		358114	
	18			357115		358115	
2	8	67	44	357121		358121	
	10			357122		358122	
	12			357123		358123	
	15			357124		358124	
	18			357125		358125	
3	8	71	47	357131		358131	
	10			357132		358132	
	12			357133		358133	
	15			357134		358134	
	18			357135		358135	
4	8	77	50	357141	358141		
	10			357142	358142		
	12			357143	358143		
	15			357144	358144		
	18			357145	358145		
5	8	81	54	357151	358151		
	10			357152	358152		
	12			357153	358153		
	15			357154	358154		
	18			357155	358155		
6	8	86	57	357161	358161		
	10			357162	358162		
	12			357163	358163		
	15			357164	358164		
	18			357165	358165		

ÚVOD

KYČEL

KOLENO

PALEC

SVS - Vložka

Materiál: • (ISO 5834-2) UHMWPE

ÚVOD

KYČEL

KOLENO

PALEC

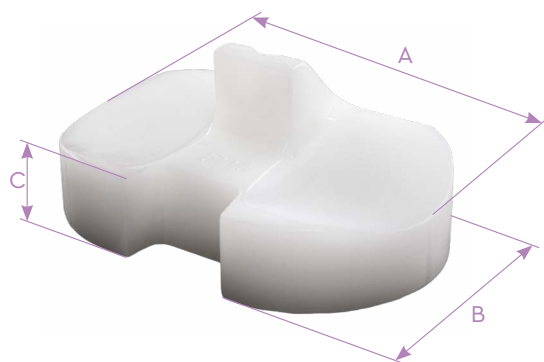

Velikost	C [mm]	A [mm]	B [mm]	Levé vložky		Pravé vložky	
				Objednací číslo	Kód VZP	Objednací číslo	Kód VZP
1	8	62	40	351221	77770	352221	77776
	10			351222		352222	
	12			351223		352223	
	15			351224		352224	
	18			351225		352225	
2	8	67	44	351231	77771	352231	77777
	10			351232		352232	
	12			351233		352233	
	15			351234		352234	
	18			351235		352235	
3	8	71	47	351241	77772	352241	77778
	10			351242		352242	
	12			351243		352243	
	15			351244		352244	
	18			351245		352245	
4	8	77	50	351251	77773	352251	77779
	10			351252		352252	
	12			351253		352253	
	15			351254		352254	
	18			351255		352255	
5	8	81	54	351261	77774	352261	77780
	10			351262		352262	
	12			351263		352263	
	15			351264		352264	
	18			351265		352265	
6	8	86	57	351271	77775	352271	77781
	10			351272		352272	
	12			351273		352273	
	15			351274		352274	
	18			351275		352275	

SVL/RP - Vložka

Materiál: • (ISO 5834-2) UHMWPE

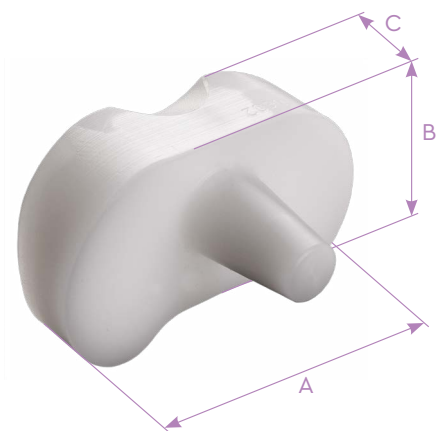

Velikost	C [mm]	A [mm]	B [mm]	Levé vložky		Pravé vložky	
				Objednací číslo	Kód VZP	Objednací číslo	Kód VZP
1	8	59		356301	110045	356401	110045
	10			356302	110045	356402	110045
	12			356303	110045	356403	110045
	15			356304	110045	356404	110045
2	8	62	34	356311	97593	356411	97599
	10			356312	97593	356412	97600
	12			356313	97593	356413	97600
	15			356314	97594	356414	97600
3	8	65	37	356321	97594	356421	97601
	10			356322	97594	356422	97601
	12			356323	97595	356423	97601
	15			356324	97595	356424	97602
4/3	8	69	41	356336	107255	356436	107255
	10			356337	107255	356437	107255
	12			356338	107255	356438	107255
	15			356339	107255	356439	107255
4	8	69	41	356331	97595	356431	97602
	10			356332	97596	356432	97602
	12			356333	97596	356433	97603
	15			356334	97596	356434	97603
5	8	74	45	356341	97597	356441	97603
	10			356342	97597	356442	97604
	12			356343	97597	356443	97604
	15			356344	97598	356444	97604
6	8	79	49	356351	97598	356451	97605
	10			356352	97598	356452	97605
	12			356353	97599	356453	97605
	15			356354	97599	356454	97606

ŮVOD

KYČEL

KOLENO

PALEC

SVL/SVR - Vložka

Materiál: • (ISO 5834-2) UHMWPE



Velikost	C [mm]	A [mm]	B [mm]	Objednací číslo	Kód VZP
1	8	60	37	358301	84811
	10			358302	
	12			358303	
	15			358304	
	18			358305	
2	8	65	39	358311	84813
	10			358312	
	12			358313	
	15			358314	
	18			358315	
3	8	70	42	358321	84815
	10			358322	
	12			358323	
	15			358324	
	18			358325	
4	8	75	46	358331	84817
	10			358332	
	12			358333	
	15			358334	
	18			358335	
5	8	80	50	358341	84819
	10			358342	
	12			358343	
	15			358344	
	18			358345	
6	8	85	54	358351	84821
	10			358352	
	12			358353	
	15			358354	
	18			358355	

ÚVOD

KYČEL

KOLENO

PALEC

Patella

- Materiál:**
- (ISO 5834-2) Patella - UHMWPE
 - (ISO 5832-1) Diagnostický drát - Tvářená korozivzdorná ocel



Velikost	ØD [mm]	Objednací číslo	Kód VZP
1	25	355500	76934
2	28	355502	
3	31	355504	
4	34	355506	

ÚVOD

KYČEL

KOLENO

PALEC

ÚVOD

KYČEL

KOLENO

PALEC

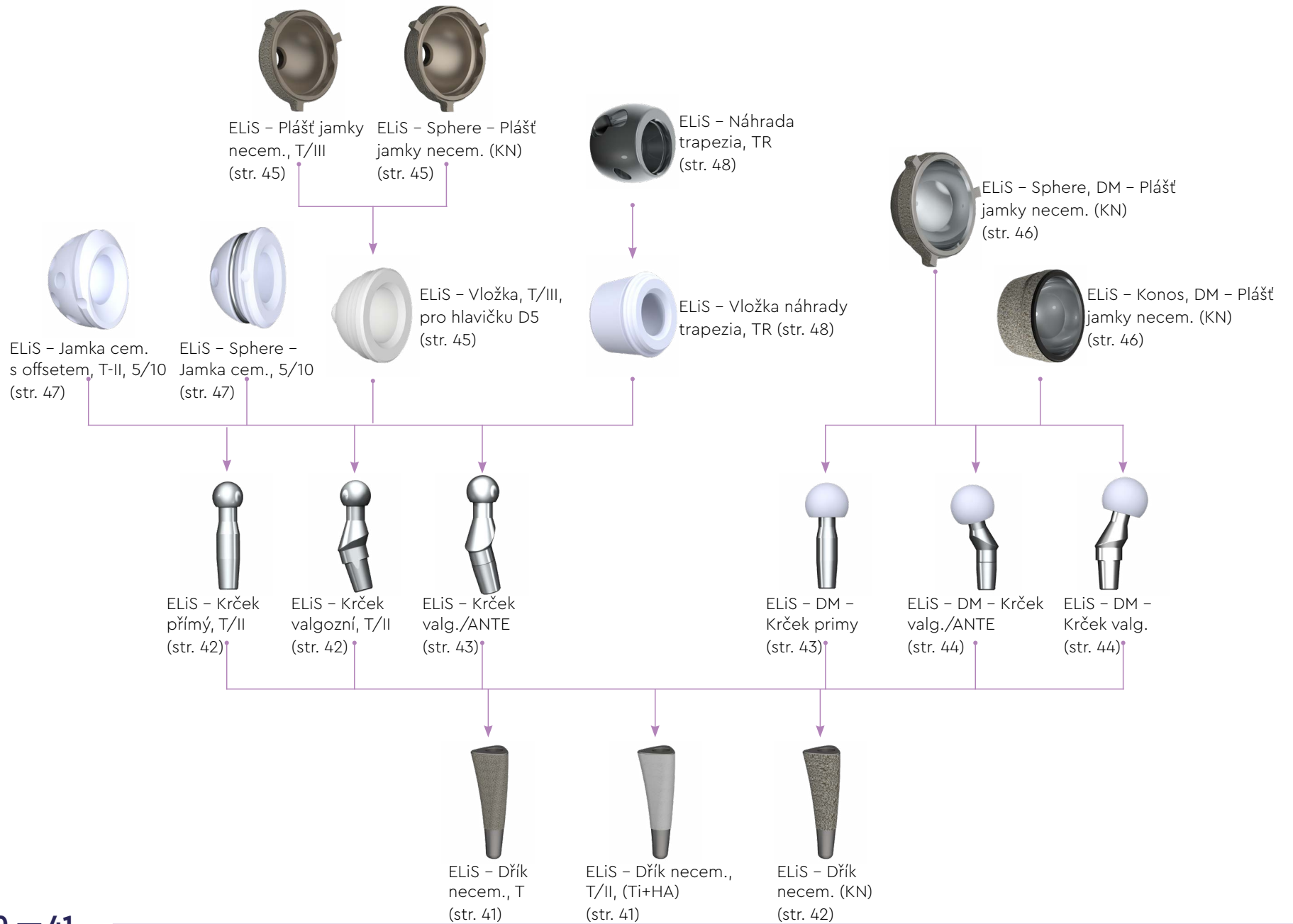

ELIS – Dřík necementovaný, T

- Materiál:**
- (ISO 5832-3) Dřík - Ti6Al4V
 - (ISO 5832-2) Porézní vrstva - Nelegovaný titan

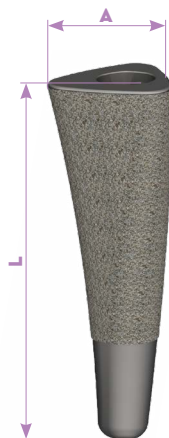

Velikost	L [mm]	A [mm]	Objednací číslo	Kód VZP
1	26	7	413001	083192
2	27	8	413002	
3	29	9	413003	
4	30	10	413004	
5	32	11	413005	

ELIS – Dřík necementovaný, T/II, (Ti+HA)

- Materiál:**
- (ISO 5832-3) Dřík - Ti6Al4V
 - (ISO 5832-2 + ISO 13779-2) Porézní vrstva - Nelegovaný titan + Hydroxyapatit



Velikost	L [mm]	A [mm]	Objednací číslo	Kód VZP
1	26	7	413011	113270
2	27	8	413012	
3	29	9	413013	
4	30	10	413014	
5	32	11	413015	

ŮVOD

KYČEL

KOLENO

PALEC

ELiS - Dřík necementovaný (KN)

- Materiál:**
- (ISO 5832-3) Dřík - Ti6Al4V
 - (ISO 5832-2 + ISO 13779-2) Porézní vrstva - Nelegovaný titan + Hydroxyapatit (Kompozitní nástřík)

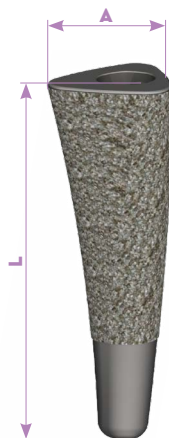

Velikost	L [mm]	A [mm]	Objednáací číslo	Kód VZP
1	26	7	413021	116624
1+	26	8	413026	
2	27	8	413022	
2+	27	9	413027	
3	29	9	413023	
4	30	10	413024	
5	32	11	413025	
5+	32	12	413028	

ELiS - Krček, T/II

- Materiál:**
- (ISO 5832-12) CoCrMo tvářený

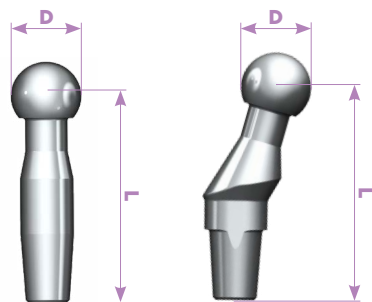

Varianta	L [mm]	D [mm]	Objednáací číslo	Kód VZP
Přímý	12	5	413072	113274
	14		413073	
	16		413074	
	18		413075	
Valg. 15°	12		413077	113275
	14		413078	
	16		413079	
	18		413080	

ELiS – Krček valgózní 15°, ANTE

Materiál: • (ISO 5832-12) CoCrMo tvářený

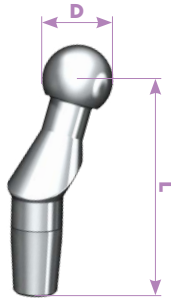

Varianta	L [mm]	D [mm]	Objednáací číslo	Kód VZP
ANTE-R	12	5	413087	116627
	14		413088	
	16		413089	
	18		413090	
ANTE-L	12		413097	
	14		413098	
	16		413099	
	18		413100	

ELiS – DM – Krček přímý

Materiál: • (ISO 5832-12) Krček - CoCrMo tvářený
• (ISO 5834-2) DM hlavička - Crosslinked UHMWPE

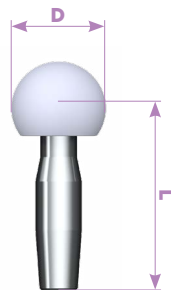

L [mm]	D [mm]	Objednáací číslo	Kód VZP
12	7,7	413062	116630
14		413063	
16		413064	
18		413065	

ŮVOD

KYČEL

KOLENO

PALEČ

ELiS - DM - Krček valgózní 15°

- Materiál:**
- (ISO 5832-12) Krček - CoCrMo tvářený
 - (ISO 5834-2) DM hlavička - Crosslinked UHMWPE

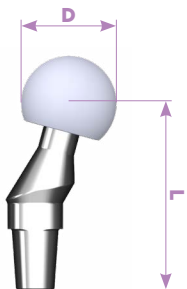

L [mm]	D [mm]	Objednací číslo	Kód VZP
12	7,7	413067	116631
14		413068	
16		413069	
18		413070	

ELiS - DM - Krček valgózní 15°, ANTE

- Materiál:**
- (ISO 5832-12) Krček - CoCrMo tvářený
 - (ISO 5834-2) DM hlavička - Crosslinked UHMWPE

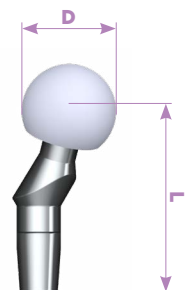

Varianta	L [mm]	D [mm]	Objednací číslo	Kód VZP
ANTE-L	12	7,7	413054	116632
	14		413055	
	16		413056	
	18		413057	
ANTE-R	12		413058	
	14		413059	
	16		413060	
	18		413061	

ELiS – Plášť jamka necem., T/III

- Materiál:**
- (ISO 5832-3) Plášť - Ti6Al4V
 - (ISO 5832-2 + ISO 13779-2) Porézní vrstva - Nelegovaný titan + Hydroxyapatit

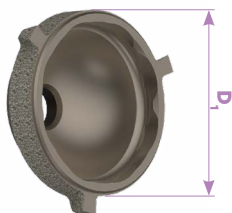

D ₁ [mm]	Objednací číslo	Kód VZP
9	413171	114588
10	413172	

ELiS – Sphere – Plášť jamky necem. (KN)

- Materiál:**
- (ISO 5832-3) Plášť - Ti6Al4V
 - (ISO 5832-2 + ISO 13779-2) Porézní vrstva - Nelegovaný titan + Hydroxyapatit (Kompozitní nástřík)

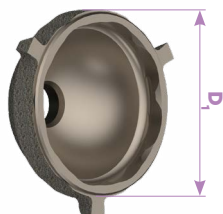

D ₁ [mm]	Objednací číslo	Kód VZP
9	413173	116625
10	413174	

ELiS – Vložka, T/III, pro hlavičku D5

- Materiál:**
- (ISO 5834-2) Crosslinked UHMWPE

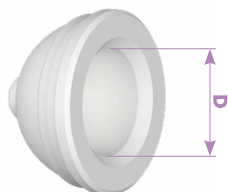

D [mm]	Objednací číslo	Kód VZP
5	413175	114589

ŮVOD

KYČEL

KOLENO

PALEC

ELiS – Sphere, DM – Plášť jamky necem. (KN)

Materiál:

- (ISO 5832-3) Plášť - Ti6Al4V
- (ISO 5832-2 + ISO 13779-2) Porézní vrstva - Nelegovaný titan + Hydroxyapatit (Kompozitní nástřík)



D ₁ [mm]	Objednáací číslo	Kód VZP
9	413176	116628
10	413177	

ELiS – Konos, DM – Plášť jamky necem. (KN)

Materiál:

- (ISO 5832-3) Plášť - Ti6Al4V
- (ISO 5832-2 + ISO 13779-2) Porézní vrstva - Nelegovaný titan + Hydroxyapatit (Kompozitní nástřík)



D ₁ [mm]	Objednáací číslo	Kód VZP
9	413178	116629
10	413179	

ÚVOD

KYČEL

KOLENO

PALEC

ELiS – Jamka cem. s offsetem, T/II, 5/10

Materiál: • (ISO 5834-2) Crosslinked UHMWPE

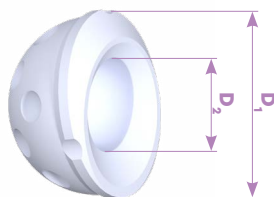

D ₁ [mm]	D ₂ [mm]	Objednací číslo	Kód VZP
10	5	413082	113276

ELiS – Sphere – Jamka cem.

Materiál: • (ISO 5834-2) Jamka - Crosslinked UHMWPE
• (ISO 5832-1) Diagnostický drát - Tvářená korozivzdorná ocel

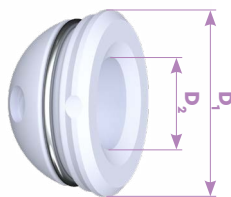

D ₁ [mm]	D ₂ [mm]	Objednací číslo	Kód VZP
10	5	413092	116626

ÚVOD

KYČEL

KOLENO

PALEC

ELiS – Náhrada trapézia, TR

Materiál: • (ISO 5832-12) CoCrMo tvárený



A/B – C [mm]	Objednací číslo	Kód VZP
14/15 – 9	413180	114590
15/16 – 10	413181	
16/17 – 11	413182	

ELiS – Vložka náhrady trapézia, TR

Materiál: • (ISO 5834-2) Crosslinked UHMWPE

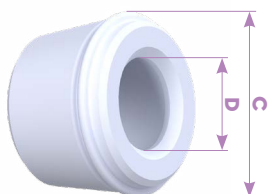

C/D [mm]	Objednací číslo	Kód VZP
9/5	413190	114591
10/5	413191	
11/5	413192	

ÚVOD

KYČEL

KOLENO

PALEC

PRIMOIMPLANTÁTY

Poznámky

ÚVOD

KYČEL

KOLENO

PALEC

ÚVOD

KYČEL

KOLENO

PALEC

PRIMOIMPLANTÁTY

Prodej a servis

Mgr. Jana Praslička Bacíková

+420 602 620 425

jana.bacikova@beznoska.cz

Ing. Josef Chalupa

+420 724 831 360

josef.chalupa@beznoska.cz

Petr Nový

+420 602 244 670

petr.novy@beznoska.cz

Obchodní úsek

+420 312 811 215

vladimira.semoradova@beznoska.cz



**back
in motion**

BEZNOSKA, s.r.o.

Dělnická 2727, Kročehlavy

272 01 Kladno

Česká republika

+420 312 660 670

mailbox@beznoska.cz

www.beznoska.cz

CE 1014
CE 2265